

Part No	L@100KHz/1V (μH)	Tolerance	I _{SAT} Typ. (A)	I _{SAT} Max. (A)	I _R Typ. (A)	I _R Max. (A)	R _{DC} ±20% (mΩ)	E
A8040-151M	150	±20%	1.20	1.03	0.98	0.90	410	3.7±0.3
A8040-221M	220	±20%	0.99	0.90	0.85	0.76	610	3.7±0.3

will cause the coil temperature rise approximately 40°C
 will cause L to drop approximately 30%.

Typical Electrical Characteristics:

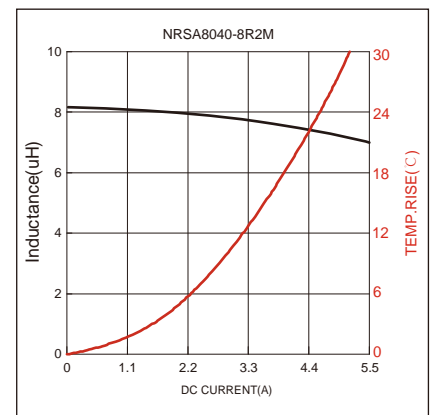

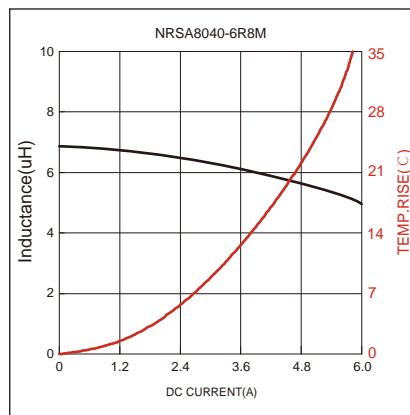
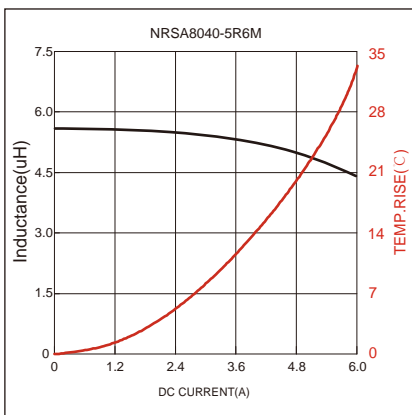
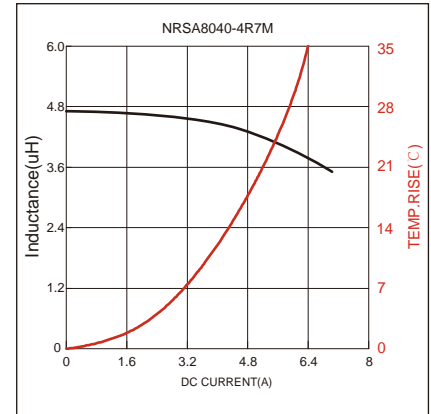
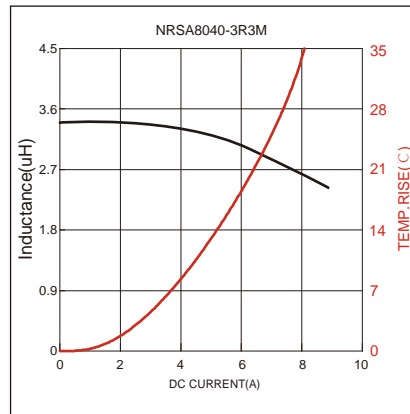
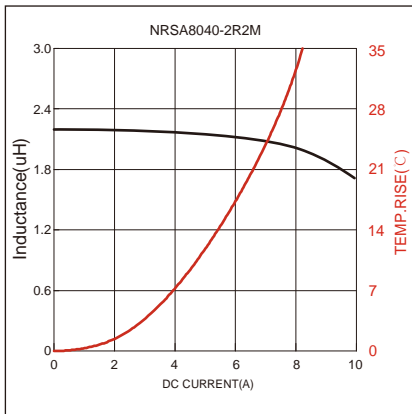
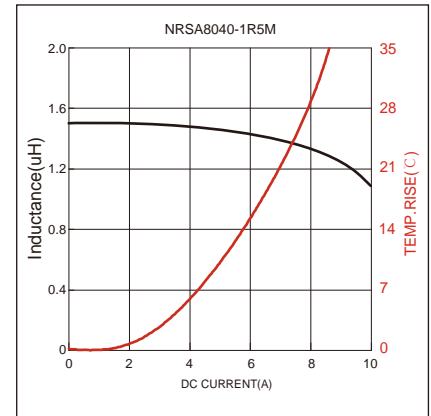
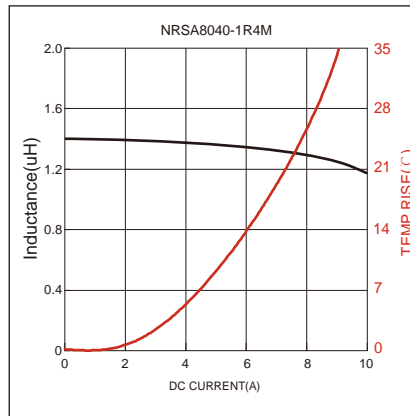
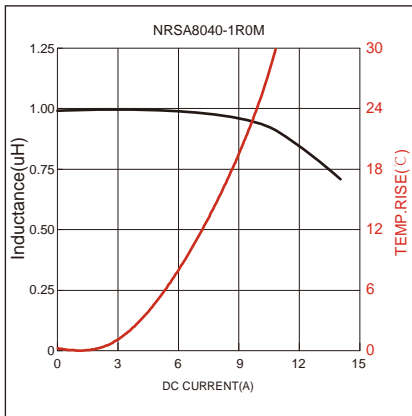
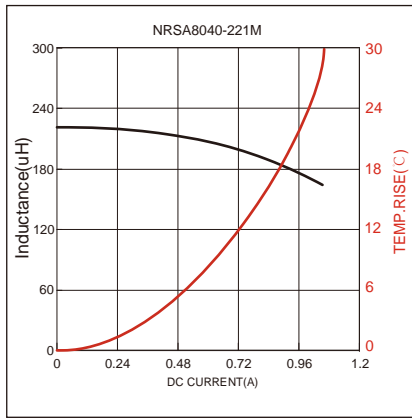
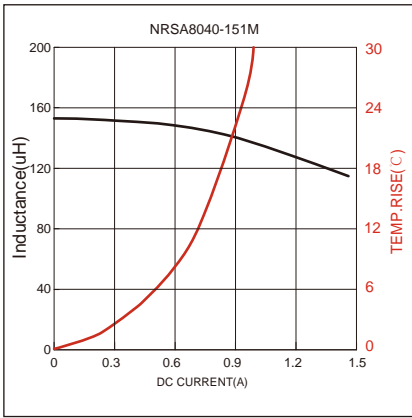
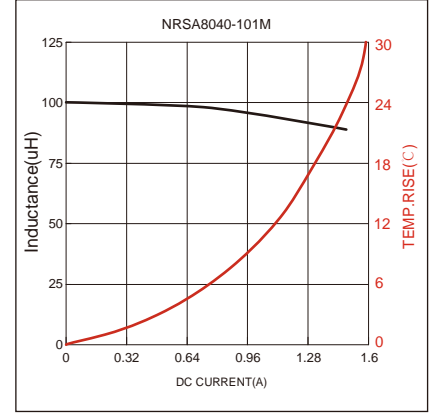
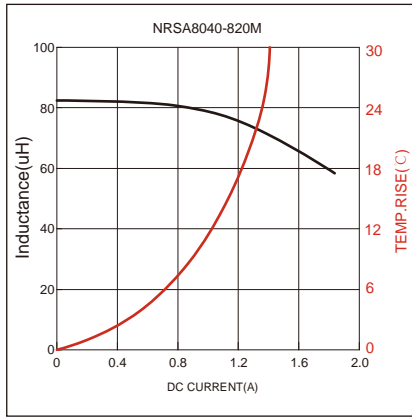
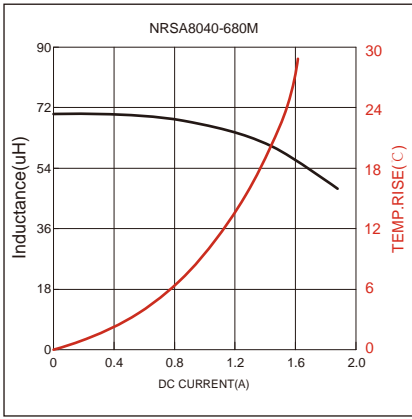
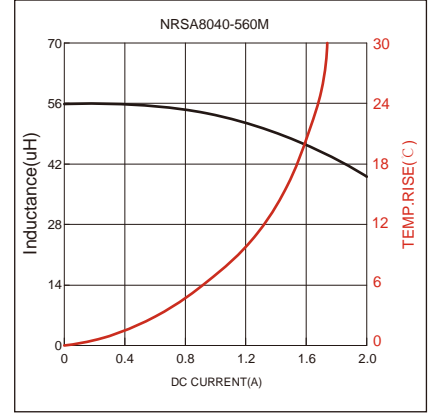
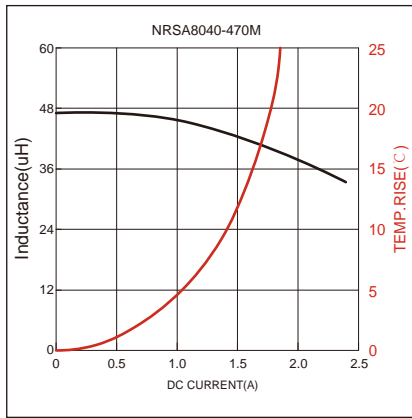
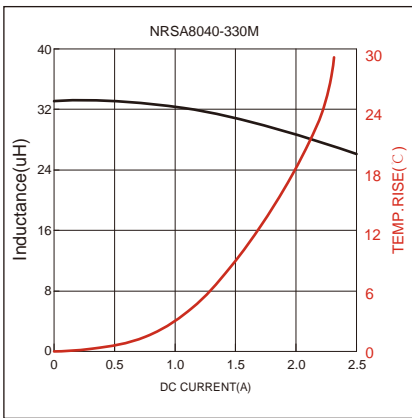
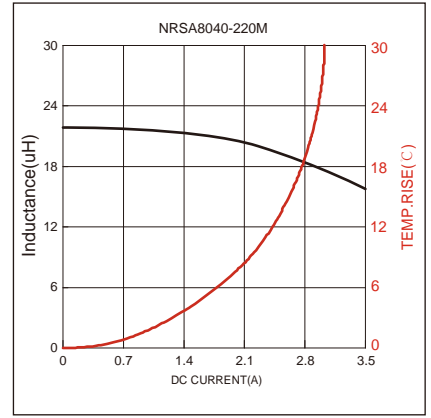
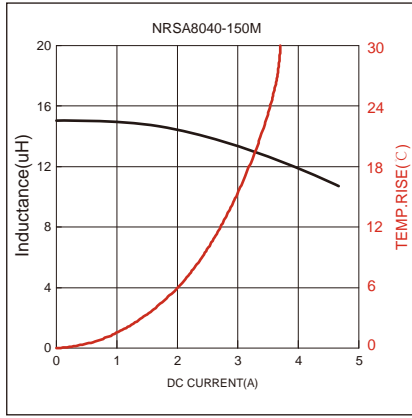
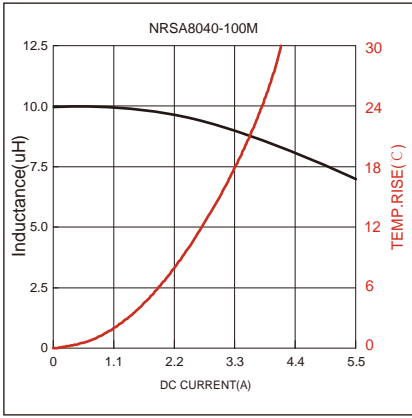

Soldering Reflow:

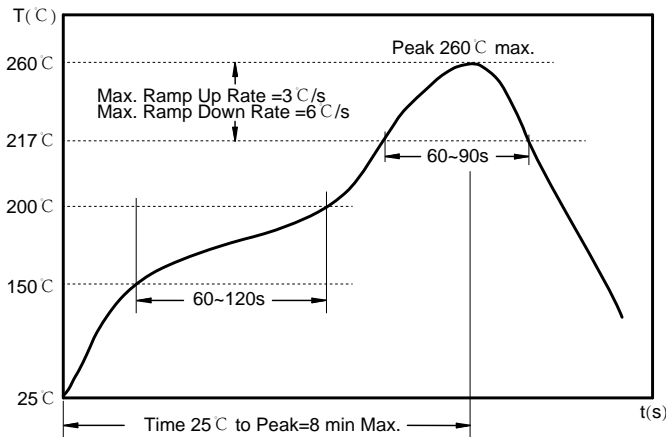

Preheat condition: 150 ~200 °C / 60~120 sec.

Allowed time above 217 °C : 60~90 sec.

Max temperature: 260 °C .

Allowed Reflow time: 2x max.

Packaging Information:

Tape Dimension :

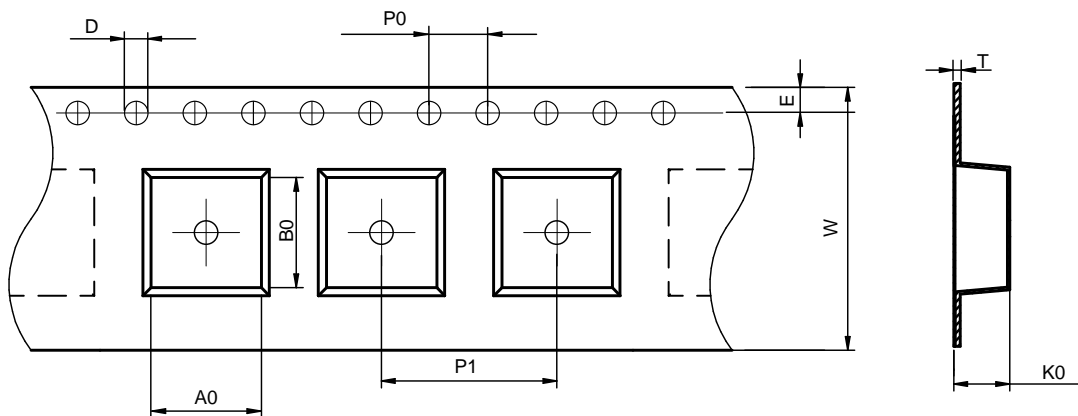

Series	A0 (mm)	B0 (mm)	D (mm)	P0 (mm)	P1 (mm)	W (mm)	K0 (mm)	E (mm)	T (mm)
NRSA8040	8.55±0.1	8.55±0.1	1.5±0.1	4.0±0.1	12.0±0.1	16.0±0.3	4.4±0.1	1.75±0.1	0.40±0.05

Peel force of top cover tape:

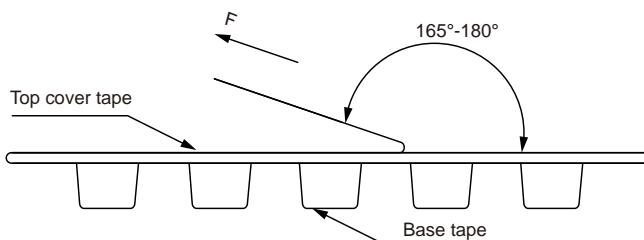

The peel force of top cover tape shall be between 0.3 to 1.17 N

Product Marking:

Marking	Printing (Inductance)
---------	-----------------------

Reel Dimension: [mm]

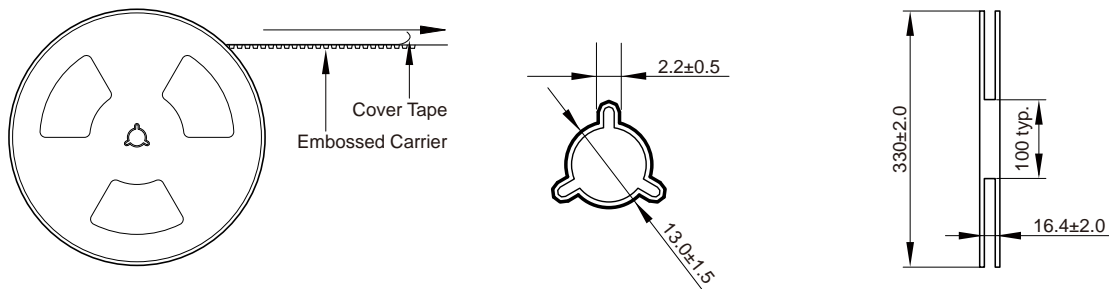

Packaging Quantity:

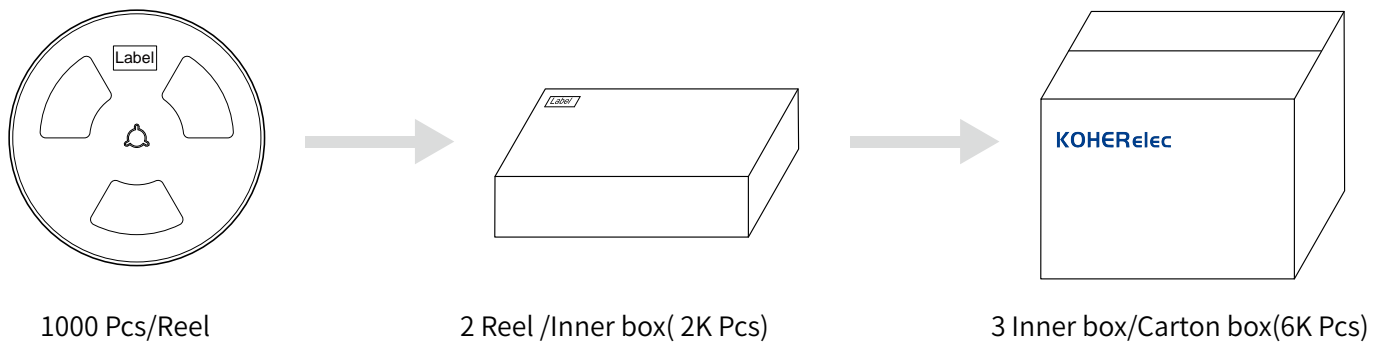

Cautions and Warnings:

Storage Conditions :

- The storage period is within 12 months after the completion of production. Be sure to follow the storage conditions (temperature: -5 to 35°C, humidity: 75% RH Max).If the storage period elapses, the soldering of the terminal electrodes may deteriorate.The warranty period is one year.
- Product should not be exposed to environment with high temperature, high humidity, dust, corrosive gas and etc.
- Products should be handled with care to avoid damage or contamination from perspiration and skin oils.
- Please always handle products carefully to prevent any damage caused by dropping down or inappropriate removing.

Operation Instructions:

- Self heating (temperature increase) occurs when the power is turned ON, so the tolerance should be sufficient for the set thermal design.
- Before soldering, be sure to preheat components.The preheating temperature should be set so that the temperature difference between the solder temperature and chip temperature does not exceed 150°C.
- Soldering corrections after mounting should be within the range of the conditions determined in the specifications.If overheated, a short circuit, performance deterioration, or lifespan shortening may occur.
- Generally, Koher might not be familiar with either customer's specific application or actual requests as customer does.As a result customer shall be responsible for checking and confirming whether Koher product with the performance described in the product specification is suitable for using in customer's particular application or not.