

MDA Series

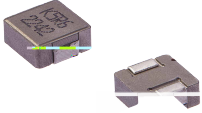

FEATURES

-
- Capable of corresponding high frequency .
- Low loss realized with low DCR.
- High performance (Isat) realized by metal dust core.
-
- 100% Lead(Pb)-Free and RoHS compliant.
-
-
-

APPLICATION

-
- HVAC
-
- Audio subsystem
- Digital instrument cluster
-

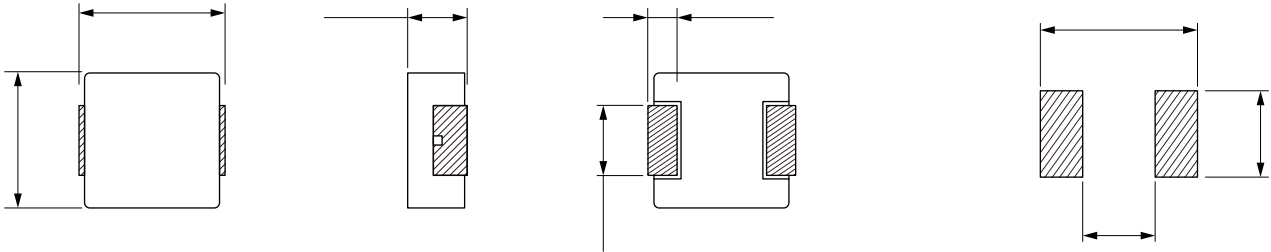

	(μ H)				Saturation	Saturation	(m Ω)	(m Ω)
MDA7030-R15N	0.15	\pm 30%	30.0	25.0	40.0	36.0	1.70	2.10
MDA7030-R22M	0.22	\pm 20%	23.0	21.0	34.0	32.0	2.00	2.50
MDA7030-R33M	0.33	\pm 20%	21.0	20.0	25.0	22.0	2.80	3.40
MDA7030-R36M	0.36	\pm 20%	20.0	18.0	24.0	21.0	3.30	3.90
MDA7030-R47M	0.47	\pm 20%	18.0	16.0	20.0	18.0	3.40	4.00
MDA7030-R56M	0.56	\pm 20%	16.5	15.0	18.0	16.0	3.90	4.50
MDA7030-R68M	0.68	\pm 20%	16.0	14.5	17.0	15.0	4.70	5.30
MDA7030-R82M	0.82	\pm 20%	14.0	13.0	16.0	14.0	5.40	6.00
MDA7030-1R0M	1.00	\pm 20%	12.0	11.0	15.0	13.5	6.70	7.40
MDA7030-1R2M	1.20	\pm 20%	10.0	9.5	14.0	12.5	7.70	9.50

Saturation

±20%	14.0	10.2
±20%	10.0	13.5
±20%	9.5	19.0
±20%	6.5	28.0
±20%	6.0	39.0
±20%	6.0	43.0
±20%	6.0	54.0
±20%	5.5	62.0
±20%	4.5	110
±20%	3.0	150
±20%	2.5	215
±20%	2.0	318



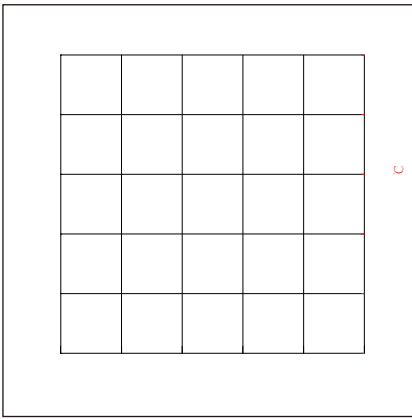
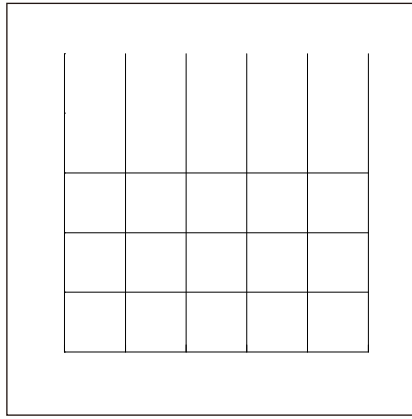
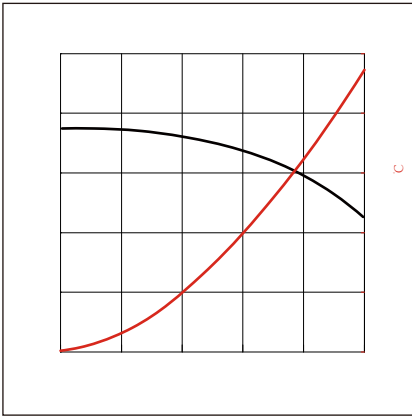

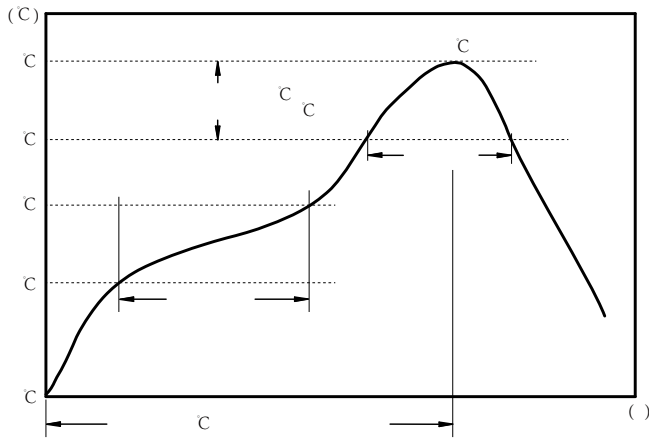

c
c
c

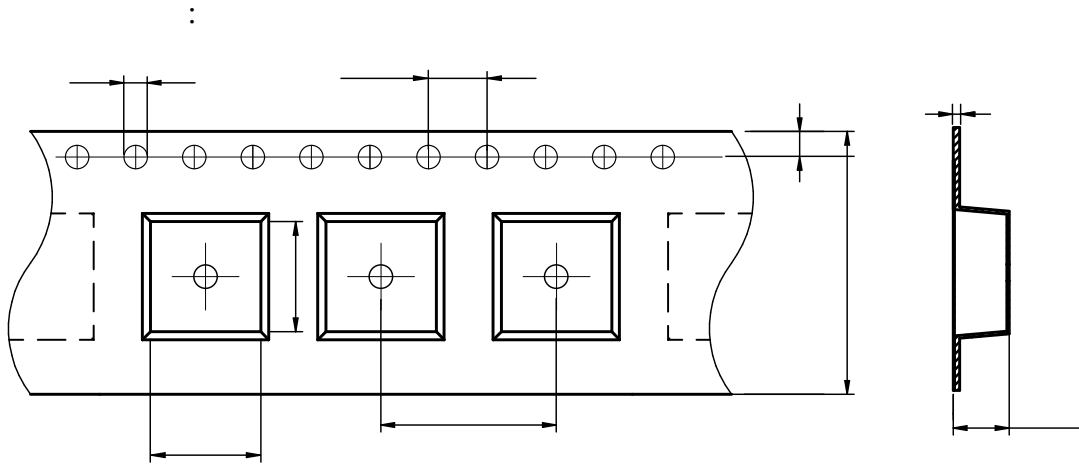

MDA7030	7.0±0.1	7.7±0.1	1.5±0.1	4.0±0.1	12.0±0.1	16.0±0.3	3.4±0.1	1.75±0.1	0.35±0.05

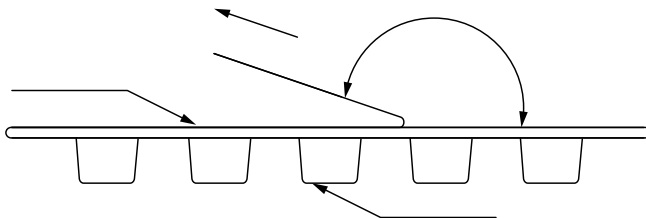

The peel force of top cover tape shall be between 0.1 to 1.3 N

Marking	K+Printing (Inductance+period)
---------	--------------------------------

:

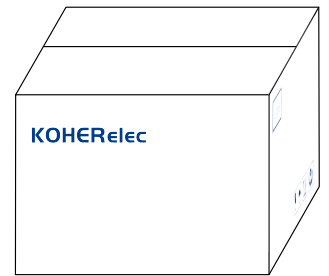
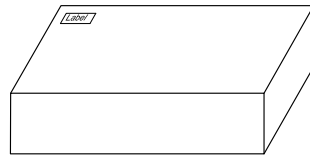
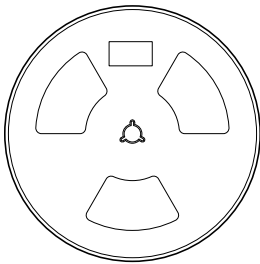
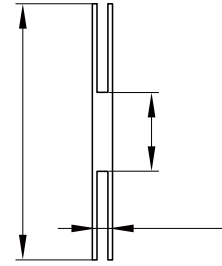
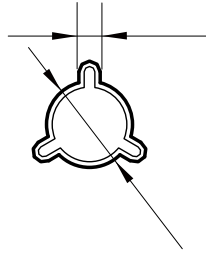
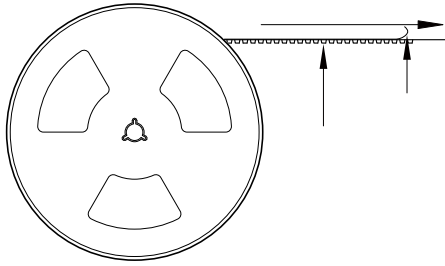

1000 Pcs/Reel

2 Reel /Inner box(2000 Pcs)

3 Inner box/Carton box(6K Pcs)

:

-
-
-
-
-
-
-
-
-